

VALVOLE MONO/BITUBO MONO/BITUBE VALVE

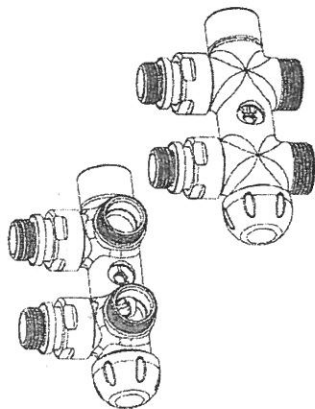

Valvola modello mono / bitubo tramite by-pass, versione a squadra o dritta con attacchi per tubo rame o plastica. Interasse 50mm.
Mono / bitube valve model by by-pass, angled or straight version with connections for copper or plastic pipe. Outlet centres 50 mm.

1. CONFIGURAZIONE / CONFIGURATION

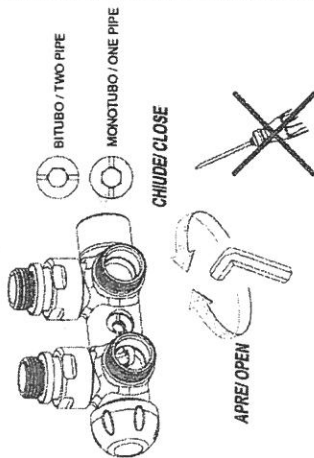

NON USARE CACCIAVITE
DON'T USE SCREWDRIVER

La configurazione può essere selezionata direttamente sul corpo valvola. Per la configurazione bitubo, chiudere il by-pass posizionando il taglio di riferimento in verticale. Per monotubo, aprire il by-pass posizionando il taglio di riferimento in orizzontale.

The configuration can be selected directly on the valve body. For a two-pipe configuration, close the by-pass by placing the switch in the upright position. For one-pipe configuration, open the by-pass by placing the switch in the horizontal position.

INSTALLAZIONE INSTALLATIONS

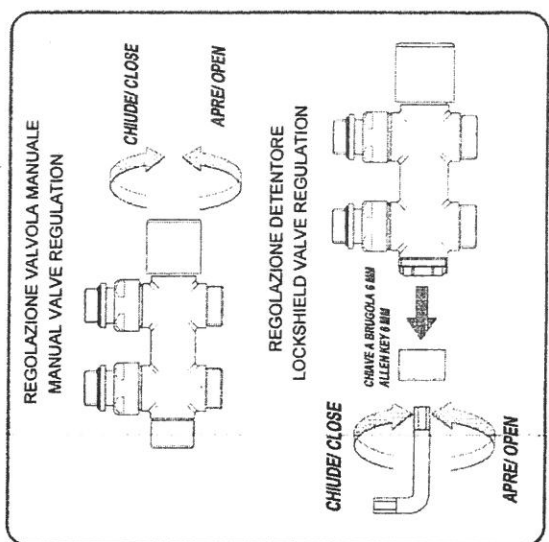
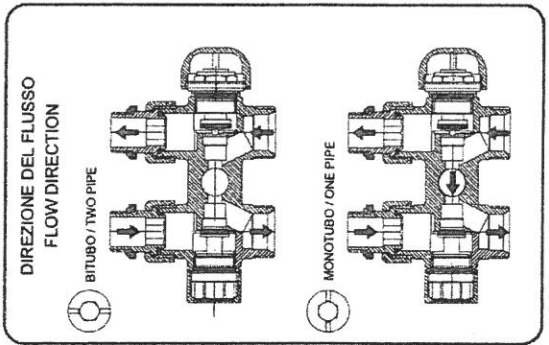
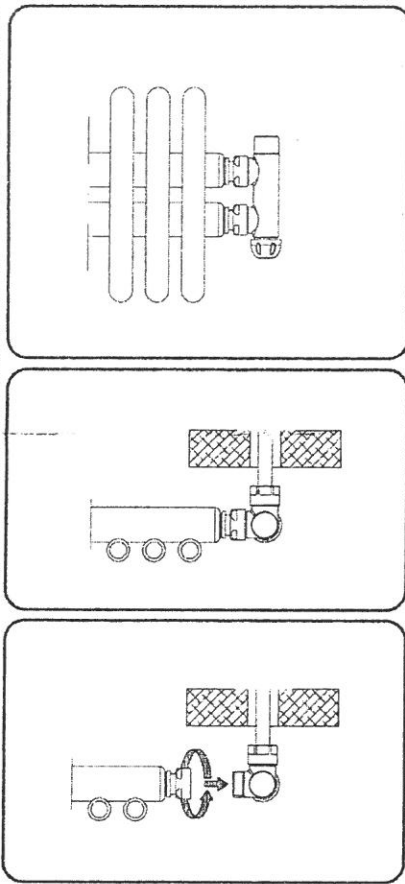
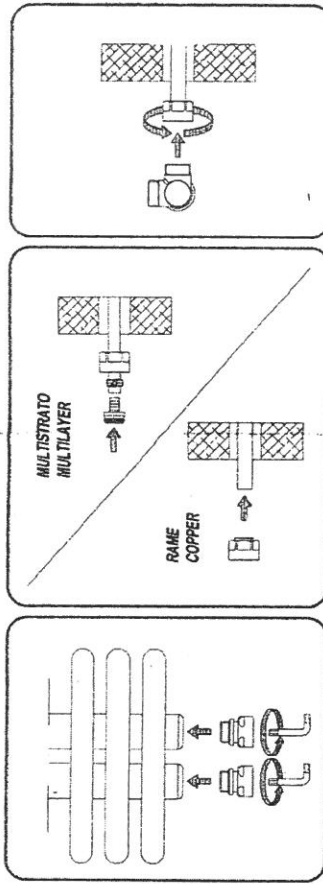

PREREGOLAZIONE PRESETTING

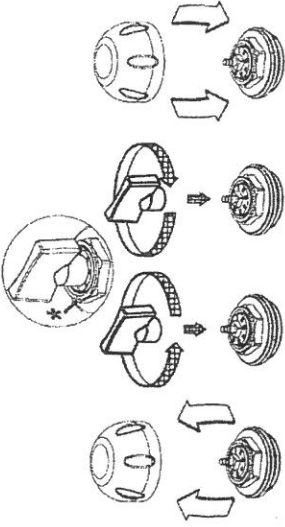

1. Togliere il cappuccio / Take off the cap;
2. Chiudere vite di prerregolazione / Close presetting ring nut;
3. Installare prerregolazione disedratata / Install presetting in desired position;
4. Mettere il cappuccio / Install the cap.

TESTA TERMOSTATICA THERMOSTATIC HEAD

INSTALLAZIONE / INSTALLATION

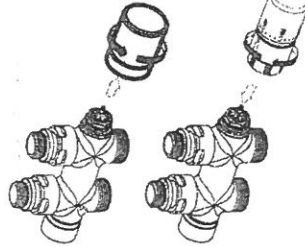

1. Togliere il cappuccio di protezione / Take off the protection cap;
2. Selezionare l'impostazione "5" sulla testa termostatica / Select setting "5" on the thermostatic head;
3. Installare la testa termostatica avvitando manualmente / Install the thermostatic head by screwing it manually.

REGOLAZIONE / REGULATION

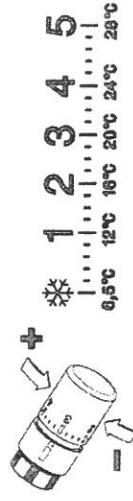

POSIZIONE / POSITION

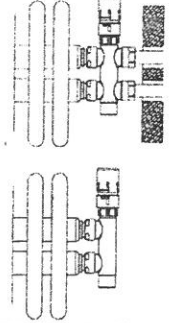

SQUADRA / ANGLED

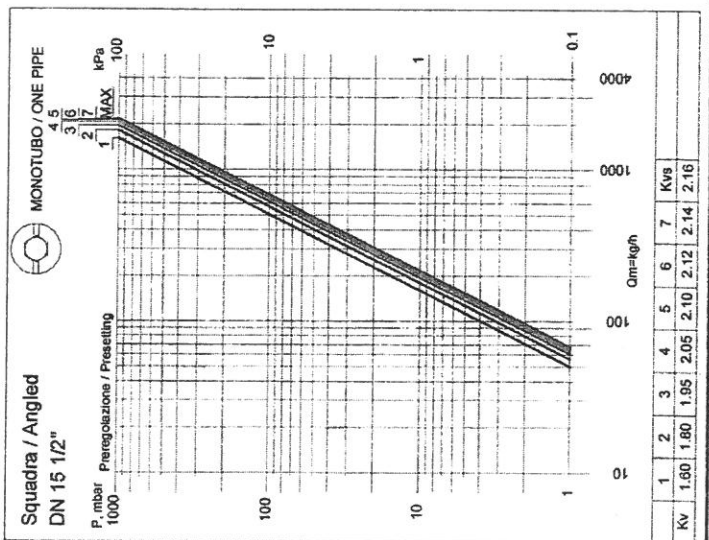
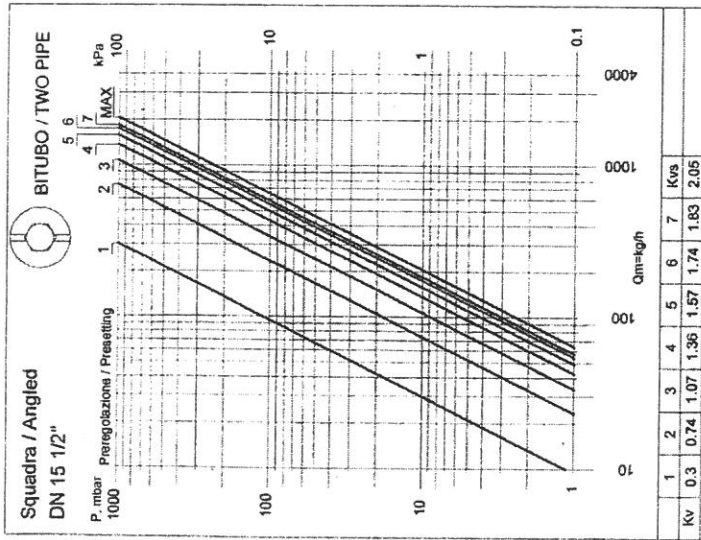

DIRITTA / STRAIGHT

